

Braytron

FIȘĂ TEHNICĂ

MODEL

BY90-01213

DESCRIERE

BRY-28x28mm-100pcs/bag-PA66-WHT-CABLE TIES MOUNT PAD

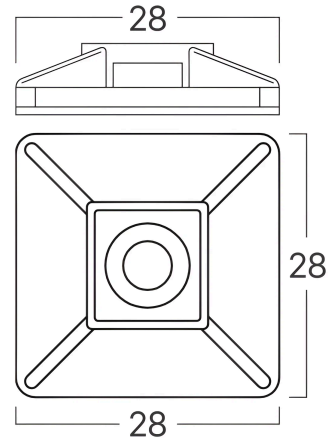

BRAYTRON LIGHTING

Bd. Iuliu Maniu, Nr.616, Sector 6, 061129, Bucuresti - ROMANIA
info@braytron.com
www.braytron.com

SPOTVISION ELECTRIC & LIGHTING S.R.L

Bd. Iuliu Maniu, Nr.616, Sector 6, 061129, Bucuresti - ROMANIA
sales@spotvisionelectric.ro
www.spotvisionelectric.ro

Pagina 1 din 2

Caracteristici Generale

Model	:	BY90-01213
Familia principală/Categorie	:	Electrice
Sub-familia/Subcategorie	:	Cable Ties
Tip	:	Mount Pad
Culoarea corpului	:	White
Garanție	:	2 Years

Caracteristici Electrice

Material	:	PA66
Temperatura de lucru	:	-40°C ~ +85°C

Dimensiuni si Greutati

Lungime	:	28 mm
Lățime	:	28 mm

Informatii despre ambalaj

Bucăți pe cutie (PCS/CTN)	:	200
Lungime	:	55 cm
Lățime	:	40 cm
Înălțime	:	21 cm
Cod EAN	:	5949097752957